

QUINCAILLERIE INTÉRIEUR + VESTIAIRES
INTERIOR HARDWARE + CLOAKROOM SYSTEMS

BLACKLINE CATALOGUS

INTERIEURACCESSOIRES & GARDEROBESYSTEMEN
BAU- UND MÖBELBESCHLÄGE + GARDEROBEN



hermeta

OUR COLOURS

geanodiseerd | anodisé | eloxiert | anodized



18

mat zwart
noir mat
matt schwarz
matt black

geëpoxeerd | thermolaqué | kunststofbeschichtet | epoxy plastic coated



70

zwart
noir
schwarz
black
RAL 9005



74

grafiet grijs
gris graphite
graphit grau
graphite grey
RAL 7024

X'TENZ geëpoxeerd, fijn structuur | thermolaqué, structure fine
kunststoffbeschichtet, feinstruktur | epoxy plastic coated, fine structure



49

antraciet
antracite
anthrazit
anthrazyt
RAL 7021

kunststof | plastic



80

zwart*
noir*
schwarz*
black*

*gerecycled kunststof

*plastique recyclé

*recycelter Kunststoff

*recycled plastic



INHOUDSOPGAVE

Kleuroverzicht	0	3. Wandgarderobes	36	8. Deurtoebehoren	82
Inhoudsopgave				Deurbuffers	83
Inhoudsopgave Nederlands	2	4. Leuninghouders	38	9. Register	
Inhoudsopgave Frans	3	Leuninghouders	40, 41, 44, 45	Artikelnummers	84
Inhoudsopgave Duits	4	Leuninghouders	42, 43, 46, 47	Product overzicht	86-88
Inhoudsopgave Engels	5	Accessoires	49	Colofon	90
1. Over Hermeta	6				
Aluminium,		5. Grepen	50		
bijzonder materiaal	10	Handgrepen	52-54		
Hermeta Blackline	14	Handgrepen Life	54		
		Meubelgrepen	55		
2. Haken	16	Schuifdeurkommen	56-59		
Handdoekhaken	18	Meubelknoppen	60-62		
Jashaken Originals	22-23				
Jashaken	24-25	6. Wandsteunen	63		
Jashaken voor					
plafondbevestiging	28	7. Gardelux®			
Magneethaak	29	garderobesystemen	64-81		
X'tenz haken	30-35	Gardelux® ANNA	66-69		
		Onderdelen Gardelux 1	70-81		
		Garderobebeuizen	70		
		Eindsteunen	71-72		
		Steunen	71-79		
		Kledinghangers	80		
		Haken	81		

TABLE DES MATIÈRES

couleurs	0	3. Porte manteaux	36	8. produits pour portes	82
contenu				Arrêts de porte	83
contenu néerlandais	2	4. Support de main		9. registre	
contenu français	3	courante	38	registre de numéro	84
contenu allemand	4	Support de main	40, 41, 44, 45	mot clé registre	86-88
contenu anglais	5	Support de main	42, 43, 46, 47	colophon	90
		courante Life	42, 43, 46, 47		
1. À propos d'Hermeta	6	Accessoires	49		
Aluminium, un matériau					
particulier	10				
Hermeta Blackline	14	5. Poignées	50		
		Poignées	52-54		
2. Crochets	16	Poignées	54		
Crochets pour		Poignées de meuble	55		
essuie-mains	18	Poignée cuvette porte			
Crochets portemanteau		coulissante	56-59		
Originals	22-23	Boutons de meuble	60-62		
Crochets portemanteau	24-25			6. Equerre d'assemblage	63
Crochet pour fixation					
au plafond	28			7. Gardelux® vestiaires	64-81
Crochet magnetiques	29	Gardelux® ANNA	66-69		
Crochets X'tenz	30-35		70-81		
		Tringle	70		
		Support d'extremites			
		pour fixation laterale	71-72		
		Supports	71-79		
		Cintres	80		
		Crochets de vestiaire	81		



INHALTSVERZEICHNIS

Farben	0	3. Garderobeleisten	36	8. Produkte für Türen	82
Inhalt				Türpuffer	83
Inhalt Niederländisch	2	4. Handlaufstutze	38		
Inhalt Französisch	3	Handlaufstutze	40, 41, 44, 45	9. Register	
Inhalt Deutsch	4	Handlaufstutze		Nummernregister	84
Inhalt Englisch	5	Life	42, 43, 46, 47	Schlüsselwortregister	86-88
		Zubehör	49	Kolophon	90
1. Über Hermeta	6				
Aluminium, ein ganz besonderes Material	10	5. Griffe	50		
Hermeta Blackline	14	Griffe	52-54		
		Griffe	54		
		Schubladengriffe	55		
2. Haken	16	Muschelgriffe			
Handtuchhaken	18	fur Schiebetur	56-59		
Mantelhaken Originals	22-23	Moebelknoepfe	60-62		
Mantelhaken	24-25				
Mantelhaken fur Deckenbefestigung	28	6. Montagewinkel	63		
Magnethaken	29				
X'tenz Haken	30-35	7. Gardelux®			
		Garderoben	64-81		
		Gardelux® ANNA	66-69, 70-81		
		Gardenrobenrohr	70		
		Wandlager für seitliche Befestigung	71-72		
		Träger	71-79		
		Kleiderbügel	80		
		Garderobenhaken	81		

INDEX

colours	0	3. Coat racks	36	8. products for doors	82
index				Doorchecks	83
index dutch	2	4. Handrail bracket	38		
index french	3	Handrail bracket	40, 41, 44, 45	9. register	
index german	4	Handrail bracket		number register	84
index english	5	Life	42, 43, 46, 47	keyword register	86-88
		Accessories	49	colophon	90
1. About Hermeta	6				
Aluminium, a special material	10	5. Handles	50		
Hermeta Blackline	14	Handles	52-54		
		Handles	54		
		Drawer handles	55		
		Flush pull	56-59		
2. Hooks	16	Cupboard knobs	60-62		
Towel hooks	18			6. Corner clasp	63
Coat hooks Originals	22-23				
Coat hooks	24-25			7. Gardelux®	
Coat hook for ceiling mounting	28			cloakroom systems	64-81
Magnetic hooks	29			Gardelux® ANNA	66-69, 70-81
X'tenz hooks	30-35			Wardrobe tubing	70
				Brackets for side wall mounting	71-72
				Brackets	71-79
				Coat hangers	80
				Hat and coat hooks	81



over Hermeta

Hermeta levert al bijna 100 jaar duurzame producten die comfort brengen in gebouwen, zoals bouw- en meubelbeslag, Gardelux® garderobes en jashaken. Hermeta levert een breed pakket aan producten met als basismateriaal gerecycled aluminium. Kwaliteit, comfort en functioneel design staan centraal. Hermeta presenteert vanuit Nederlands vakmanschap innovatieve oplossingen. Ook duurzaamheid staat hoog in het vaandel. Om invulling hieraan te geven heeft Hermeta twee labels geïntroduceerd, Hermeta Life en Hermeta Blue, die bijdragen aan mens en milieu.

HERMETA LIFE

Onder het label Hermeta Life ontwikkelt Hermeta producten en oplossingen die bijdragen aan de gezondheid, veiligheid en toegankelijkheid voor de mens in zijn omgeving. De producten passen in een levensloopbestendige leefomgeving. Hermeta houdt rekening met verschillende gebruikers, ook met kinderen, ouderen en met mensen met een beperking. Voorbeelden van producten zijn de leuninghouders Life, waarmee leuningen voor iedereen goed zijn beet te pakken.

HERMETA BLUE

Hermeta wil met het ontwikkelen van veilige producten, gemaakt van duurzame materialen, bijdragen aan een schone en leefbare wereld voor iedereen. De producten, die onder het label Hermeta Blue vallen, zijn ontworpen voor hergebruik of worden gemaakt van minimaal 75% gerecycled aluminium. Zo is alle gebruikte stroom groene stroom en is al het gasgebruik bos-gecompenseerd. Hermeta gebruikt groene energie voor haar zo onschadelijk mogelijke productie-processen. Zo probeert Hermeta de wereld te behouden voor latere generaties. Hermeta heeft in 2018 het certificaat Cradle to Cradle Silver ontvangen voor de Gardelux Fit en voor Hermeta bouwen meubelbeslag producten.



CERTIFICATION
3692



FSC® PRODUCTEN OP AANVRAAG



À PROPOS D'HERMETA

Depuis près d'un siècle, Hermeta fournit des produits durables qui apportent un confort d'utilisation, tels que des accessoires pour le bâtiment, l'agencement et le mobilier, des vestiaires Gardelux® et des patères / porte-manteaux. Hermeta produit une large gamme d'articles à base d'aluminium recyclé. La qualité, le confort et la conception fonctionnelle sont essentiels. Hermeta présente des solutions innovantes basées sur l'artisanat néerlandais. La durabilité est également d'une importance primordiale. Pour donner corps à cela, Hermeta a introduit deux labels, Hermeta Life et Hermeta Blue, qui contribuent au respect de l'homme et de l'environnement.

HERMETA LIFE

Le Traité de l'ONU sur les Droits des Handicapés a été ratifié par les Pays-Bas en 2016. Cela signifie que tous les êtres humains doivent pouvoir participer de manière égale et respectueuse au sein de notre société. Hermeta développe sous le label de Hermeta Life des produits et des solutions qui améliorent la santé, la sécurité et l'accessibilité



life



blue

pour l'homme dans son cadre de vie. Dans le développement du produit, Hermeta tient compte des différents utilisateurs, aussi des enfants, de personnes âgées et de handicapés. La Norme d'accessibilité intégrale néerlandaise (ITS, la norme aux Pays-Bas pour l'accessibilité de l'environnement bâti), la norme allemande comparable DIN 18040, ainsi que la norme FDCEN/TR 15894 valable en France, sont employées par Hermeta comme des références importantes pour la création de produits pour un cadre de vie accessible.

HERMETA BLUE

Hermeta vise à fournir une contribution à un monde propre et vivable pour tout un chacun en développant des produits sûrs, fabriqués à base de matériaux sains. Les produits de la marque Hermeta Blue ont été conçus pour être recyclés ou sont fabriqués en aluminium recyclé à 75% au moins. Ainsi toute l'électricité utilisée est du courant vert et toute la consommation en gaz est compensée au niveau des forêts. Hermeta utilise de l'énergie verte pour ses processus de production les plus inoffensifs possibles. Ainsi Hermeta essaie de préserver la terre pour les générations futures. Hermeta a obtenu en 2018 le certificat Cradle to Cradle Silver pour sa collection de Gardelux Fit et pour les garnitures pour le bâtiment et le mobilier.





ÜBER HERMETA

Hermeta liefert seit fast 100 Jahren nachhaltige Produkte, die Komfort in Gebäude bringen, wie zum Beispiel Bau- und Innen-Beschläge, Gardelux® Garderobes und Mantelhaken. Hermeta liefert eine breite Palette von Produkten auf der Basis von wiederverwendetem Aluminium. Qualität, Komfort und funktionales Design stehen im Mittelpunkt. Hermeta präsentiert innovative Lösungen auf der Grundlage niederländischer Handwerkskunst. Auch die Nachhaltigkeit ist von größter Bedeutung. Um dies zu konkretisieren, hat Hermeta zwei Labels eingeführt, Hermeta Life und Hermeta Blue, die einen Beitrag für Mensch und Umwelt leisten.

HERMETA LIFE

Die UN-Konvention über die Rechte der Menschen mit Behinderungen wurde 2016 von den Niederlanden ratifiziert. Das heißt, dass alle Menschen in der Lage sein müssen, auf gleiche und respektvolle Weise an unserer Gesellschaft teilzunehmen. Unter dem Label Hermeta Life entwickelt Hermeta Produkte und Lösungen, die zur Gesundheit, Sicherheit und Zugänglichkeit für Menschen in ihrer Umgebung beitragen. Im Rahmen der Produktentwicklung berücksichtigt Hermeta die unterschiedlichen Nutzer, darunter Kinder, ältere Menschen und Menschen mit Behinderungen. Hermeta verwendet den ITS, die niederländische Norm für die Zugänglichkeit der bebauten Umgebung, die vergleichbare deutsche Norm DIN 18040, sowie die in Frankreich geltende FDCEN/TR 15894 als wichtige Referenzen für die Entwicklung der Produkte für eine zugängliche Wohnumgebung.

HERMETA BLUE

Durch die Entwicklung sicherer Produkte aus nachhaltigen Materialien will Hermeta zu einer sauberen und lebenswerten Welt für alle beitragen. Die Produkte, die unter dem Blue-Label von Hermeta stehen, sind für die Wiederverwendung bestimmt oder bestehen aus mindestens 75% recyceltem Aluminium. Wir nutzen ausschließlich Ökostrom und Gas wird mit Waldförderung eingekauft. Für seine Produktionsprozesse verwendet Hermeta grüne Energie, die so umweltverträglich wie möglich ist. Auf diese Weise versucht Hermeta, den Planeten für spätere Generationen zu erhalten. Im Jahr 2018 erhielt Hermeta das Cradle to Cradle Silver Zertifikat für Gardelux Fit und für Hermeta Bau- und Möbelbeschläge.

ABOUT HERMETA

Hermeta has been supplying durable products that bring comfort to buildings for almost 100 years, such as building and furniture fittings, Gardelux® wardrobes and coat hooks. Hermeta supplies a wide range of products based on recycled aluminium. Quality, comfort and functional design are central. Hermeta presents innovative solutions based on Dutch craftsmanship. Sustainability is also of paramount importance. To give substance to this, Hermeta has introduced two labels, Hermeta Life and Hermeta Blue, which contribute to people and the environment.

HERMETA LIFE

The UN Convention on the Rights of Persons with Disabilities was ratified by the Netherlands in 2016. This means that all people must be able to participate in our society in an equal and respectful way. Under the Hermeta Life label, Hermeta develops products and solutions that contribute to health, safety and accessibility for people in their environment. During product development, Hermeta considers its different users, including children, the elderly and people with disabilities. Hermeta uses the ITS, the Dutch standard for accessibility in the built environment, the comparable German standard DIN 18040, as well as the FDCEN/TR 15894 that applies in France, as important references for creating products for an accessible living environment.

HERMETA BLUE

By developing safe products made from sustainable materials, Hermeta wants to contribute to a cleaner and more liveable world for everyone. The products that fall under the Hermeta Blue label are designed for reuse or are made from at least 75% recycled aluminium. For example, all the electricity used is green electricity and all the gas used is compensated by woodland planting. Hermeta uses green energy for its production processes, which are as harmless as possible. In doing so, Hermeta tries to preserve the world for later generations. In 2018, Hermeta received the Cradle to Cradle Silver certificate for the Gardelux Fit and for Hermeta construction and furniture fittings.



ALUMINIUM,

Een bijzonder materiaal



Aluminium is een licht metaal en door toevoeging van legeringselementen is het ook een sterk metaal. De aluminiumlegeringen, waaronder het eigen L45, die Hermeta toepast, zijn optimaal om een mooi en sterk product te maken met veel vormvrijheid. Producten van aluminium gaan lang mee. Wordt het product toch afgedankt, dan kan het aluminium weer door Hermeta worden hergebruikt.

Dit maakt het een ideaal materiaal voor een circulaire wereld. Mede hierdoor en door de continue aandacht voor een duurzame productiewijze heeft Hermeta het Cradle to Cradle Silver-Certificaat gekregen. Het oppervlak van aluminium is zeer dicht en ondoordringbaar. Het is een dermatologisch vriendelijk materiaal. Daarmee is het een uitkomst voor toepassingen waar hoge hygiënische eisen aan worden gesteld. Zo is aluminium bijvoorbeeld geschikt voor mensen met een nikkelallergie. Hermeta verwerkt aluminiumprofielen in diverse producten en heeft eigen productiefaciliteiten in Nederland voor geobotiseerd en handmatig gieten van aluminium.

OPPERVLAKTE-BEHANDELINGEN: ANODISEREN EN POEDERCOATEN

Aluminium heeft van nature een gesloten oxidelaag, die het onderliggende metaal beschermt. Anodiseren is een kunstmatig

aangebrachte sterk verdichte aluminium oxidelaag, die ontstaat onder invloed van stroom in een nat chemisch proces. In België wordt dit proces vaak eloxeren genoemd. Deze anodiseerlaag is hard, beschermt tegen corrosie en geeft het product een mooier uiterlijk. Hermeta kan haar aluminium producten zelf anodiseren en biedt geanodiseerd aluminium in diverse kleuren aan.

ALUMINIUM, UN MATÉRIAU PARTICULIER

L'aluminium est un métal léger et par l'addition d'éléments d'alliage c'est un métal solide aussi. Les alliages d'aluminium, dont le propre L45, appliqué par Hermeta, sont des meilleurs pour fabriquer un beau produit solide offrant une grande malléabilité. Les produits en aluminium ont une longue durée de vie. Hermeta garantit même que ses produits restent à 100% libres de corrosion toute la vie. Si le produit est néanmoins mis à la décharge, l'aluminium peut être recyclé par Hermeta. Cela en fait un matériel idéal pour un monde circulaire. De ce fait entre autres et par l'attention continuelle portée au processus de production durable Hermeta a obtenu le certificat Cradle to Cradle Silver. La surface d'aluminium est très dense et impénétrable. C'est un matériau respectueux de la peau. De ce fait il offre une solution pour des applications auxquelles on pose des conditions élevées sur le plan de l'hygiène. Ainsi l'aluminium convient à des personnes allergiques au nickel.

TRAITEMENTS DE SURFACE: ANODISATION ET POUDRAGE

ÉLECTROSTATIQUE (THERMOLAQUAGE)

L'anodisation consiste en l'apport artificiel d'une couche d'oxyde hautement compactée, qui naît sous l'effet du courant dans un processus chimique humide. En Belgique ce processus est appelé souvent l'éloxage. Cette couche anodisée est dure, protège contre la corrosion et donne au produit un joli aspect. Hermeta peut anodiser elle-même ses produits en aluminium et offer de l'aluminium anodisé en diverses couleurs. Il s'agit de couleurs propres au matériau et offrant une apparence de qualité. Des différences de couleur minimales sont possibles. Appliquer un revêtement en poudre, appelé parfois aussi époxage, est une deuxième possibilité de traitement de surface. En thermolaquage toutes les couleurs RAL sont possibles. Hermeta offre standard un certain nombre de couleurs RAL.





ALUMINIUM, EIN GANZ BESONDERES MATERIAL

Aluminium ist ein Leichtmetall, aber mit dem Zusatz von Legierungselementen hat es auch die Eigenschaft eines starken Metalls. Die Aluminiumlegierungen, einschließlich der eigenen L45 von Hermeta, sind optimal für die Herstellung eines ästhetischen und soliden Produkts mit viel Formfreiheit. Aluminiumprodukte haben eine lange Lebensdauer. Hermeta garantiert, dass seine Produkte lebenslang 100% korrosionsfrei bleiben. Sollte das Produkt dennoch entsorgt werden, kann das Aluminium von Hermeta wiederverwendet werden. Somit ist es ein nachhaltiges Material für eine zirkuläre Wirtschaft. Nicht zuletzt deswegen und der ständigen Auseinandersetzung mit nachhaltigen Produktionsmethoden wurde Hermeta das Cradle to Cradle Silver Zertifikat verliehen. Eine Aluminiumoberfläche ist sehr dicht und undurchlässig. Aluminium ist ein dermatologisch unbedenkliches Material. Das macht es zu einer Lösung für Anwendungen, bei denen

ALUMINIUM, A SPECIAL MATERIAL

Aluminium is a lightweight metal but with the addition of alloying elements it is also a strong metal. The aluminium alloys, including Hermeta's own L45, are ideal for making a beautiful and strong product with great form flexibility. Aluminium products last a long time. Hermeta even guarantees that its products remain 100% corrosion-free for life. If the product is discarded, the aluminium can be reused again by Hermeta. This makes it an ideal material for a circular world. Partly for this and partly because of the continuous search for more sustainable production methods, Hermeta has been awarded the Cradle to Cradle Silver Certificate. The surface of aluminium is very dense and impermeable. It is a dermatologically friendly material. This makes it a perfect solution for applications which require strict hygienic standards. For example, aluminium is suitable for people with a nickel allergy.

hohe hygienische Anforderungen gestellt werden. Es ist sehr gut für Menschen mit einer Nickelallergie geeignet.

OBERFLÄCHENBEHANDLUNGEN: ELOXIEREN UND PULVERBESCHICHTUNG

Eloxieren ist eine künstlich aufgebraute, hochverdichtete Aluminiumoxidschicht, die unter Stromeinwirkung in einem nasschemischen Prozess gebildet wird. In den Niederlanden wird dieses Verfahren auch Anodisieren genannt. Eine eloxierte Oberfläche ist hart, schützt vor Korrosion und verleiht dem Produkt ein optisch ansprechenderes Aussehen. Hermeta ist in der Lage, seine Aluminiumprodukte selbst zu eloxieren und bietet eloxiertes Aluminium in verschiedenen Farben an. Es sind materialspezifische Farben mit einer schönen qualitativen Optik. Geringfügige Farbunterschiede sind möglich. Die Pulverbeschichtung in RAL Farben, auch Epoxidierung genannt, ist eine zweite Möglichkeit der Oberflächenbehandlung.

SURFACE TREATMENTS: ANODISING AND POWDER COATING

Aluminium naturally has a closed oxide layer, which protects the underlying metal. Anodising is an artificially applied highly compacted aluminium oxide layer, which is formed under the influence of a current in a wet chemical process. In Belgium, this process is often called eloxing. This anodised layer is hard, protects against corrosion and gives the product a more beautiful appearance. Hermeta can anodise its aluminium products itself and offers anodised aluminium in various colours. These are material-specific colours with a beautiful high-quality appearance. Minimal colour differences are possible. Powder coating is another possible surface treatment. Hermeta has its products powder coated in paint shops that specialise in working with aluminium, so that lifelong corrosion resistance can also be guaranteed. Hermeta offers a number of RAL colours as standard.



Hermeta Blackline



Hermeta werkt samen met meerdere designers. Dat resulteert vaak in prachtige producten zoals de X'tenz collectie en de wandgarderobe Gardelux ANNA. Maar dat niet alleen. De designers houden Hermeta ook scherp wat betreft de designtrends, die van invloed zijn op ons dagelijks leven en dus ook op alle producten van Hermeta. Kleur is één aspect en ideaal om ieder product een eigen karakter te geven.

Eén van de designtrends is de voorliefde voor oude industriële sferen in moderne werk- en woonomgevingen. Hermeta levert veel van haar producten ook in zwart. Deze producten zijn samengebracht in deze Black Line Catalogus. Toch stopt het voor ons niet bij zwart. We kijken verder en zien nieuwe trends in kleur opkomen.



HERMETA BLACK LINE

Hermeta coopère avec plusieurs designers, ce qui aboutit souvent à des produits splendides tels la Collection X'tenz ou Gardelux ANNA. Mais ce n'est pas tout. Les designers gardent Hermeta aussi éveillée quant aux nouvelles tendances en matière de design, qui affectent notre vie quotidienne et par conséquent aussi tous les produits de Hermeta. La couleur est l'un des aspects et un moyen idéal pour donner à chaque produit un propre caractère.

L'une des tendances au niveau du design c'est la prédilection pour d'anciennes ambiances industrielles dans les cadres de travail et de vie modernes. Hermeta participe à cette tendance et peut livrer un grand nombre de ses produits en noir aussi. Ces produits sont rassemblés dans le présent catalogue Black Line. Cependant cela ne s'arrête pas là pour nous. Nous regardons plus loin et voyons surgir de nouvelles tendances en matière de couleur

HERMETA BLACK LINE

Hermeta arbeitet mit mehreren Designern zusammen. Daraus entstehen sehr oft formschöne Produkte wie die Kabuki Collection von Edward van Vliet oder die speziellen Haken von House of Hermeta von Carina Riezebos. Doch nicht nur das. Auch im Hinblick auf Designtrends, die unseren Alltag und damit alle Hermeta-Produkte betreffen, halten die Designer Hermeta immer topaktuell. Ein Aspekt ist die Farbe und optimal, wenn es darum geht, jedem Produkt seinen eigenen Charakter zu verleihen.

Einer der Designtrends ist die Vorliebe für alte Industrielatmosphären in modernen Arbeits- und Lebenswelten. Hermeta ist mit dabei und liefert viele seiner Produkte auch in Schwarz. Diese Produkte wurden gesammelt in diesem Black Line Catalogue. Allerdings hört es für uns nicht bei Schwarz auf. Wir schauen weiter und bemerken neue Farbrends.

HERMETA BLACK LINE

Hermeta works together with several designers. This often results in beautiful products such as X'tenz and Gardelux ANNA. But not only that. The designers also keep Hermeta up-to-date with the latest design trends, which have an impact on our everyday lives and, therefore, on all of Hermeta's products. Colour is one aspect and it's ideal for giving each product its own character.

One of the design trends is the fondness for an old industrial look in modern working and living environments. Hermeta is also onboard with this trend and offers many of its products in black. These products have been collected in this Black Line Catalogue. But for us, it doesn't stop at black. We look further and can see new colour trends emerging.



0111-18

Haken
Crochets
Haken
Hooks



2 HAKEN

HANDDOEKHAKEN



HANDDOEKHAKEN	CROCHETS POUR ESSUIE-MAINS	HANDTUCHHAKEN	TOWEL HOOKS
gegoten aluminium	en fonte d'aluminium	Aluminiumguß	cast aluminium

geëpoxeerd
-70 zwart

thermolaqué
-70 noir

kunststoffbeschichtet
-70 schwarz

epoxy plastic coated
-70 black

2 HAKEN

HANDDOEKHAKEN



HANDDOEKHAKEN	CROCHETS POUR ESSUIE-MAINS	HANDTUCHHAKEN	TOWEL HOOKS
van aluminium profiel	aluminium extrudé	Aluminiumprofil	extrudé aluminium

geanodiseerd
-18 mat zwart

anodisé
-18 noir mat

eloxiert
-18 matt schwarz

anodized
-18 matt black

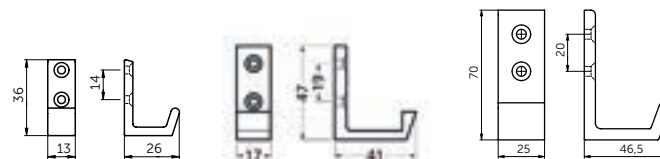



0032-70



2 HAKEN

JASHAKEN

Hermeta Originals



JASHAKEN	CROCHETS PORTEMANTEAU	MANTELHAKEN	COAT HOOKS
gegoten aluminium	en fonte d'aluminium	Aluminiumguß	cast aluminium

geëpoxeerd
-70 zwart

thermolaqué
-70 noir

kunststoffbeschichtet
-70 schwarz

epoxy plastic coated
-70 black

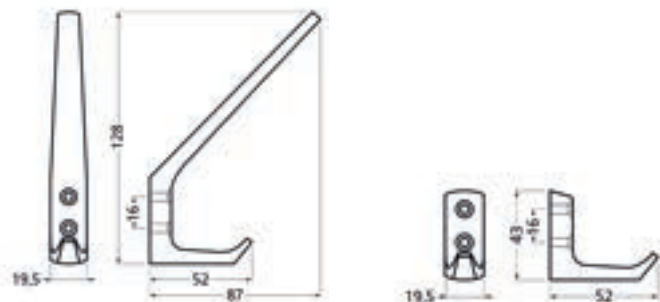

2 HAKEN

JASHAKEN

Hermeta Originals



JASHAKEN	CROCHETS PORTEMANTEAU	MANTELHAKEN	COAT HOOKS
gegoten aluminium	en fonte d'aluminium	Aluminiumguß	cast aluminium

geëpoxeerd
-70 zwart

thermolaqué
-70 noir

kunststoffbeschichtet
-70 schwarz

epoxy plastic coated
-70 black

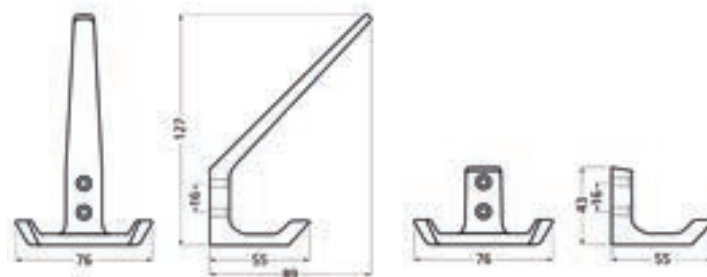

2 HAKEN

JASHAKEN



JASHAKEN	CROCHETS PORTEMANTEAU	MANTELHAKEN	COAT HOOKS
van aluminium profiel	aluminium extrudé	Aluminiumprofil	extruded aluminium
Van minstens 75% gerecycled aluminium	en aluminium recyclé à 75% au moins	aus mindestens 75% recyceltem Aluminium	at least 75% recycled aluminium
geanodiseerd -18 mat zwart	anodisé -18 noir mat	eloxiert -18 matt schwarz	anodized -18 matt black

2 HAKEN

JASHAKEN



JASHAKEN	CROCHETS PORTEMANTEAU	MANTELHAKEN	COAT HOOKS
van aluminium profiel	aluminium extrudé	Aluminiumprofil	extruded aluminium
Van minstens 75% gerecycled aluminium	en aluminium recyclé à 75% au moins	aus mindestens 75% recyceltem Aluminium	at least 75% recycled aluminium
geanodiseerd -18 mat zwart	anodisé -18 noir mat	eloxiert -18 matt schwarz	anodized -18 matt black

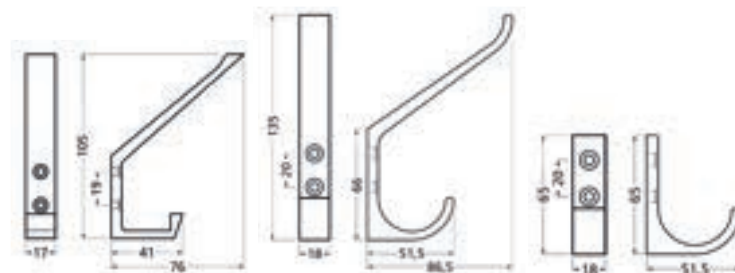
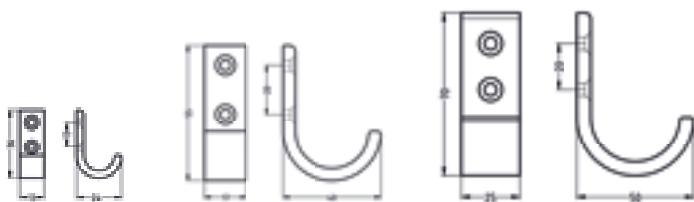



0150-18



2 HAKEN

JASHAKEN

voor plafondbevestiging



JASHAAK VOOR PLAFONDBEVESTIGING	CROCHET POUR FIXATION AU PLAFOND	MANTELHAKEN FÜR DECKENBEVESTIGUNG	COAT HOOK FOR CEILING MOUNTING
aluminium	aluminium	Aluminium	aluminium
0200 vast voor 2 jassen	0200 fixe pour 2 vestes	0200 fest für 2 Mäntel	0200 fixed for 2 coats
0201 draaibaar voor 4 jassen	0201 tournant pour 4 vestes	0201 drehbar für 4 Mäntel	0201 rotatable for 4 coats
0200 geëpoxeerd -70 zwart	0200 thermolaqué -70 noir	0200 kunststofbeschilderd -70 schwarz	0200 epoxy plastic coated -70 black
0201 geanodiseerd -18 mat zwart	0201 anodisé -18 noir mat	0201 eloxiert -18 matt schwarz	0201 anodized -18 matt black

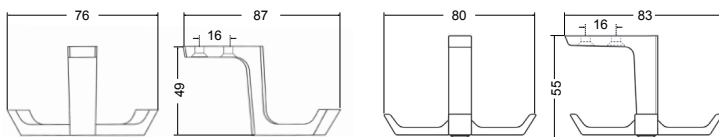

2 HAKEN

MAGNEETHAAK



MAGNEETHAAK	CROCHET MAGNÉTIQUES	MAGNETHAKEN	MAGNETIC HOOKS
van aluminium profiel	aluminium extrudé	Aluminiumprofil	extruded aluminium
Voorzien van magneet	Équipé d'un aimant	Mit Magnet ausgestattet	Equipped with a magnet
Geschikt voor stalen kasten, deurkozijnen, koelkasten ed.	Appropriée d'être accroché aux armoires, chambranles de porte, réfrigérateurs etc.	Nur für metallischen Untergrund geeignet.	Appropriate for attachment to closets, door-frames, refrigerators etc.
Draagkracht: 6 kg	Le crochet dispose d'une portance maximum de 6 kg.	Haftkraft: 6 kg	The hook is disposed of a maximum capacity of 6 kg.
geanodiseerd -18 mat zwart	anodisé -18 noir mat	eloxiert -18 matt schwarz	anodized -18 matt black

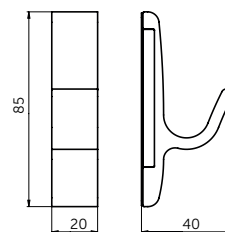



X001.01-18



X002.04-18



X003.01-49



2 HAKEN

X'TENZ HAKEN

vette haak #1



X001.01

-18

HAAK	CROCHET	HAKEN	HOOK
van aluminium profiel	aluminium extrudé	Aluminiumprofil	extruded aluminium
Van minstens 75% gerecycled aluminium	en aluminium recyclé à 75% au moins	aus mindestens 75% recyceltem Aluminium	at least 75% recycled aluminium
X001.01 geanodiseerd -18 mat zwart	X001.01 anodisé -18 noir mat	X001.01 eloxiert -18 matt schwarz	X001.01 anodized -18 matt black

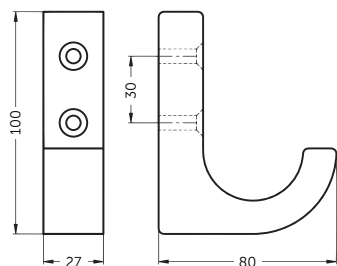

2 HAKEN

X'TENZ HAKEN

ctrl bolt

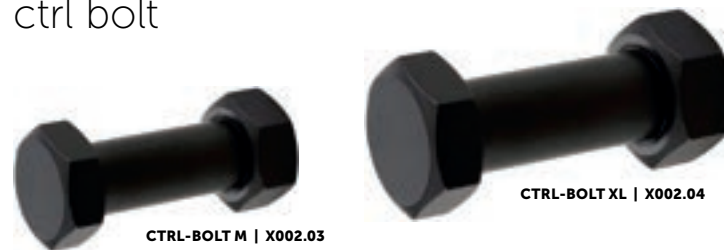

CTRL-BOLT M | X002.03

CTRL-BOLT XL | X002.04



CTRL-BOLT S | X002.01

-18

HAAK	CROCHET	HAKEN	HOOK
van aluminium profiel	aluminium extrudé	Aluminiumprofil	extruded aluminium
Van minstens 75% gerecycled aluminium	en aluminium recyclé à 75% au moins	aus mindestens 75% recyceltem Aluminium	at least 75% recycled aluminium
CTRL-BOLT S = X002.01 CTRL-BOLT XL = X002.04	CTRL-BOLT S = X002.01 CTRL-BOLT XL = X002.04	CTRL-BOLT S = X002.01 CTRL-BOLT XL = X002.04	CTRL-BOLT S = X002.01 CTRL-BOLT XL = X002.04
X002.01 Verpakking voor 3 haken. Andere aantallen mogelijk op aanvraag.	X002.01 Emballage par 3 pièces. Autres quantités possible sur demande.	X002.01 Verpackung pro 3 Stück. Andere Mengen auf Anfrage.	X002.01 Packaging per 3 pieces. Other numbers possible on request.
X002.03 Verpakking voor 1 haak	X002.03 1 Pièce par emballage.	X002.03 1 Stück pro Packung.	X002.03 Packaging per 1 piece.
X002.04 Verpakking voor 1 haak	X002.04 1 Pièce par emballage.	X002.04 1 Stück pro Packung.	X002.04 Packaging per 1 piece.
In representatieve verpakking	Dans un emballage représentatif	In repräsentativer Verpackung	In representative packaging
geanodiseerd -18 mat zwart	anodisé -18 noir mat	eloxiert -18 matt schwarz	anodized -18 matt black

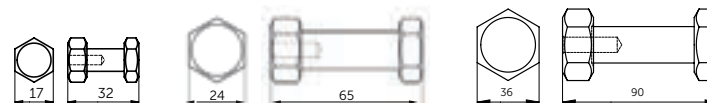

2 HAKEN

X'TENZ HAKEN

d'O en J'é



HAAK	CROCHET	HAKEN	HOOK
gegoten aluminium	en fonte d'aluminium	Aluminiumguß	cast aluminium
Van minstens 75% gerecycled aluminium	en aluminium recyclé à 75% au moins	aus mindestens 75% recyceltem Aluminium	at least 75% recycled aluminium
verpakking voor 1 haak	emballage par pièce	Verpackung pro Stück	packaging per piece
geëpoxeerd -49 antraciet (RAL 7021)	thermolaqué -49 antracite (RAL 7021)	kunststoffbeschichtet -49 anthrazit (RAL 7021)	epoxy plastic coated -49 anthrazyt (RAL 7021)

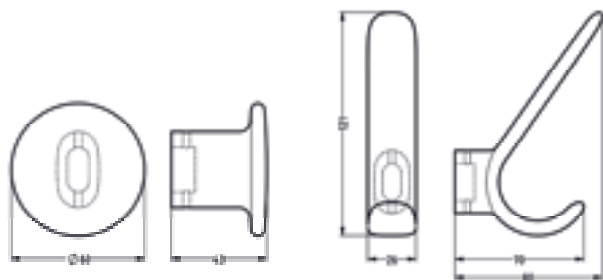

2 HAKEN

X'TENZ HAKEN

nobel



HAAK	CROCHET	HAKEN	HOOK
gegoten aluminium	en fonte d'aluminium	Aluminiumguß	cast aluminium
Van minstens 75% gerecycled aluminium	en aluminium recyclé à 75% au moins	aus mindestens 75% recyceltem Aluminium	at least 75% recycled aluminium
verpakking voor 1 haak	emballage par pièce	Verpackung pro Stück	packaging per piece
geëpoxeerd -49 antraciet (RAL 7021)	thermolaqué -49 antracite (RAL 7021)	kunststoffbeschichtet -49 anthrazit (RAL 7021)	epoxy plastic coated -49 anthrazyt (RAL 7021)

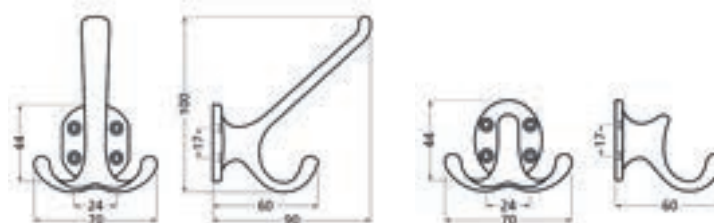

Wandgarderobes
 Porte-manteaux
 Garderobeleisten
 Coat racks



3 WANDGARDEROBES

WANDGARDEROBES



0863-74

0863-70

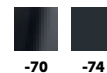

KAPSTOKGARNITUREN	PORTE-MANTEAUX	GARDEROBELEISTEN	COAT RACKS
0863 Haken en lijst in dezelfde kleur	0863 Crochets et profil de même couleur	0863 Haken und Leiste in gleiche Farber	0863 Hooks and profile in the same color
-70 zwart	-70 noir	-70 schwarz	-70 black
Haken naturel 01 geanodiseerd en lijst in kleur	Crochets en argent 01 anodisé et profil dans couleur	Haken Silber 01 eloxiert und Leiste in Farbe	Hooks silver 01 anodized and profile in color
-74 grafiet grijs	-74 gris graphite	-74 graphit grau	-74 graphite grey
Lengte: 410 mm	Longueur: 410 mm	Länge: 410 mm	Length: 410 mm



Leuninghouders
Support de main courante
Handlaufstütze
Handrail bracket



4 LEUNINGHOUDERS

LEUNINGHOUDERS



LEUNINGHOUDER	SUPPORT DE MAIN COURANTE	HANDLAUFSTÜTZE	HANDRAIL BRACKET
gegoten aluminium	en fonte d'aluminium	Aluminiumguß	cast aluminium
65 mm	65 mm	65 mm	65 mm
TÜV gecertificeerd (2400-B-233) Cradle to cradle silver gecertificeerd (3692)	Certifié TÜV (2400-B-233) Certifié argent berceau à berceau (3692)	TÜV-zertifiziert (2400-B-233) Cradle to Cradle Silber zertifiziert (3692)	TÜV certified (2400-B-233) Cradle-to-cradle silver certified (3692)
3500 holzadel, opschroevend 3501 holzadel, tapgat M8	3500 concave, 3 trous de montage 3501 concave, trou taraudé M8	3500 gewölbte Auflage, 3 Bohrungen 3501 gewölbte Auflage, Gewindebohrung M8	3500 radiused saddle, 3 fixing holes 3501 radiused saddle, M8 threaded hole
geëpoxeerd -70 zwart	thermolaqué -70 noir	kunststoffbeschichtet -70 schwarz	epoxy plastic coated -70 black

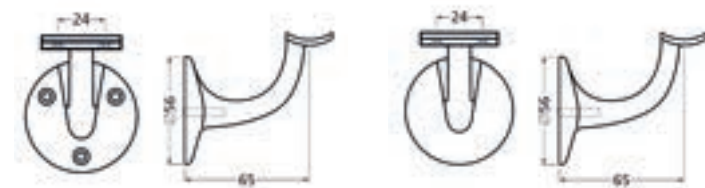

4 LEUNINGHOUDERS

LEUNINGHOUDERS



LEUNINGHOUDER	SUPPORT DE MAIN COURANTE	HANDLAUFSTÜTZE	HANDRAIL BRACKET
gegoten aluminium	en fonte d'aluminium	Aluminiumguß	cast aluminium
65 mm	65 mm	65 mm	65 mm
TÜV gecertificeerd (2400-B-233) Cradle to cradle silver gecertificeerd (3692)	Certifié TÜV (2400-B-233) Certifié argent berceau à berceau (3692)	TÜV-zertifiziert (2400-B-233) Cradle to Cradle Silber zertifiziert (3692)	TÜV certified (2400-B-233) Cradle-to-cradle silver certified (3692)
3502 vlakzadel, opschroevend 3503 vlakzadel, tapgat M8	3502 plat, 3 trous de montage 3503 plat, trou taraudé M8	3502 gerade Auflage, 3 Bohrungen 3503 gerade Auflage, Gewindebohrung M8	3502 flat saddle, 3 fixing holes 3503 flat saddle, M8 threaded hole
geëpoxeerd -70 zwart	thermolaqué -70 noir	kunststoffbeschichtet -70 schwarz	epoxy plastic coated -70 black



4 LEUNINGHOUDERS

LEUNINGHOUDERS LIFE



LEUNINGHOUDER	SUPPORT DE MAIN COURANTE	HANDLAUFSTÜTZE	HANDRAIL BRACKET
gegoten aluminium	en fonte d'aluminium	Aluminiumguß	cast aluminium
75 mm	75 mm	75 mm	75 mm
ITS gecertificeerd (3B-113-011) TÜV gecertificeerd (2400-B-606) Cradle to cradle silver gecertificeerd (3692)	Certifié ITS (3B-113-011) Certifié TÜV (2400-B-606) Certifié argent berceau à berceau (3692)	ITS zertifiziert (3B-113-011) TÜV-zertifiziert (2400-B-606) Cradle to Cradle Silber zertifiziert (3692)	ITS certified (3B-113-011) TÜV certified (2400-B-606) Cradle-to-cradle silver certified (3692)
3505 holzadel, opschroevend 3506 holzadel, taggat M8	3505 concave, 3 trous de montage 3506 concave, trou taraudé M8	3505 gewölbte Auflage, 3 Bohrungen 3506 gewölbte Auflage, Gewindebohrung M8	3505 radiused saddle, 3 fixing holes 3506 radiused saddle, M8 threaded hole
geëpoxeerd -70 zwart	thermolaqué -70 noir	kunststoffbeschichtet -70 schwarz	epoxy plastic coated -70 black

4 LEUNINGHOUDERS

LEUNINGHOUDERS LIFE



LEUNINGHOUDER	SUPPORT DE MAIN COURANTE	HANDLAUFSTÜTZE	HANDRAIL BRACKET
gegoten aluminium	en fonte d'aluminium	Aluminiumguß	cast aluminium
75 mm	75 mm	75 mm	75 mm
ITS gecertificeerd (3B-113-011) TÜV gecertificeerd (2400-B-606) Cradle to cradle silver gecertificeerd (3692)	Certifié ITS (3B-113-011) Certifié TÜV (2400-B-606) Certifié argent berceau à berceau (3692)	ITS zertifiziert (3B-113-011) TÜV-zertifiziert (2400-B-606) Cradle to Cradle Silber zertifiziert (3692)	ITS certified (3B-113-011) TÜV certified (2400-B-606) Cradle-to-cradle silver certified (3692)
3507 vlakzadel, opschroevend 3508 vlakzadel, taggat M8	3507 plat, 3 trous de montage 3508 plat, trou taraudé M8	3507 gerade Auflage, 3 Bohrungen 3508 gerade Auflage, Gewindebohrung M8	3507 flat saddle, 3 fixing holes 3508 flat saddle, M8 threaded hole
geëpoxeerd -70 zwart	thermolaqué -70 noir	kunststoffbeschichtet -70 schwarz	epoxy plastic coated -70 black

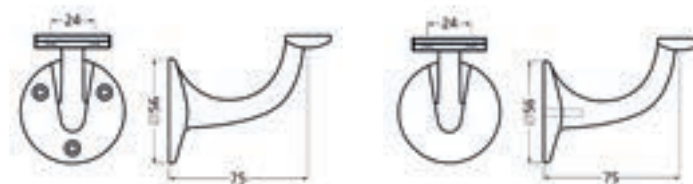
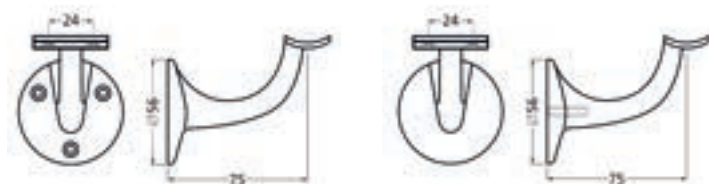

4 LEUNINGHOUDERS

LEUNINGHOUDERS



3540



3541



-18

LEUNINGHOUDER	SUPPORT DE MAIN COURANTE	HANDLAUFSTÜTZE	HANDRAIL BRACKET
van aluminium profiel	aluminium extrudé	Aluminiumprofil	extruded aluminium
65 mm	65 mm	65 mm	65 mm
TÜV gecertificeerd (2400-B-233) Cradle to cradle silver gecertificeerd (3692)	Certifié TÜV (2400-B-233) Certifié argent berceau à berceau (3692)	TÜV-zertifiziert (2400-B-233) Cradle to Cradle Silber zertifiziert (3692)	TÜV certified (2400-B-233) Cradle-to-cradle silver certified (3692)
3540 vlakzadel, opschroevend 3541 vlakzadel, met gat voor stokschroef M8	3540 plat, pour fixation au mur par vis 3541 plat, avec trou pour boulon M8	3540 gerade Auflage, zum Aufschrauben 3541 gerade Auflage, mit Loch für M8-Schraube	3540 flat saddle, for screw fixing 3541 flat saddle, with single hole for M8 fixing bolt
geanodiseerd -18 mat zwart	anodisé -18 noir mat	eloxiert -18 matt schwarz	anodized -18 matt black

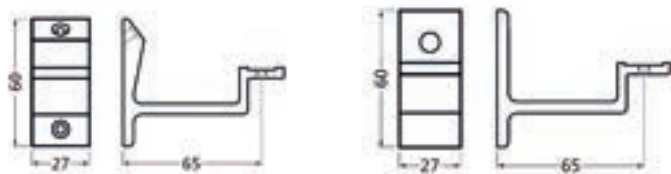

4 LEUNINGHOUDERS

LEUNINGHOUDERS



3542



3543



-18

LEUNINGHOUDER	SUPPORT DE MAIN COURANTE	HANDLAUFSTÜTZE	HANDRAIL BRACKET
van aluminium profiel	aluminium extrudé	Aluminiumprofil	extruded aluminium
65 mm	65 mm	65 mm	65 mm
TÜV gecertificeerd (2400-B-233) Cradle to cradle silver gecertificeerd (3692)	Certifié TÜV (2400-B-233) Certifié argent berceau à berceau (3692)	TÜV-zertifiziert (2400-B-233) Cradle to Cradle Silber zertifiziert (3692)	TÜV certified (2400-B-233) Cradle-to-cradle silver certified (3692)
3542 holzadel, opschroevend 3543 holzadel, met gat voor stokschroef M8	3542 concave, pour fixation au mur par vis 3543 concave, avec trou pour boulon M8	3542 gewölbte Auflage zum Aufschrauben 3543 gewölbte Auflage, mit Loch für M8 Schraube	3542 radiused saddle, for screw holes 3543 radiused saddle, with single hole for M8 fixing bolt
geanodiseerd -18 mat zwart	anodisé -18 noir mat	eloxiert -18 matt schwarz	anodized -18 matt black

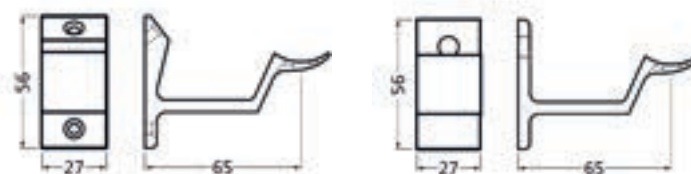

4 LEUNINGHOUDERS

LEUNINGHOUDERS LIFE

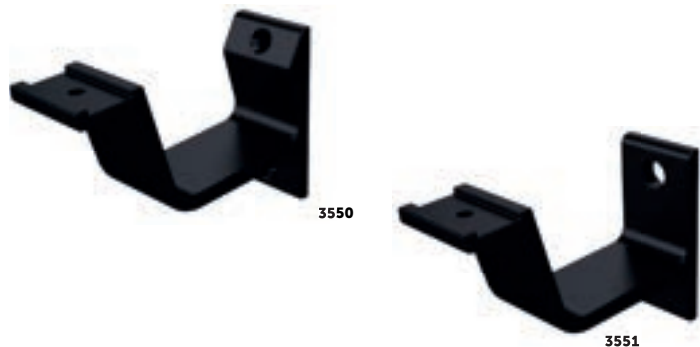

-18

LEUNINGHOUDER	SUPPORT DE MAIN COURANTE	HANDLAUFSTÜTZE	HANDRAIL BRACKET
van aluminium profiel	aluminium extrudé	Aluminiumprofil	extruded aluminium
76 mm	76 mm	76 mm	76 mm
De producten passen in een levensloopbestendige leefomgeving.	Les produits s'intègrent dans un environnement de vie résistant au cycle de la vie.	Die Produkte passen in eine Lebensphasen sichere Wohnumgebung.	The products fit well in an aging-in-place living environment.
ITS gecertificeerd (3B-113-011) TÜV gecertificeerd (2400-B-606) Cradle to cradle silver gecertificeerd (3692)	Certifié ITS (3B-113-011) Certifié TÜV (2400-B-606) Certifié argent berceau à berceau (3692)	ITS zertifiziert (3B-113-011) TÜV-zertifiziert (2400-B-606) Cradle to Cradle Silber zertifiziert (3692)	ITS certified (3B-113-011) TÜV certified (2400-B-606) Cradle-to-cradle silver certified (3692)
3550 vlakzadel, opschroevend	3550 plat, pour fixation au mur par vis	3550 gerade Auflage, zum Aufschraubenn	3550 flat saddle, for screw fixing
3551 vlakzadel, met gat voor stokschroef M8	3551 plat, avec trou pour boulon M8	3551 gerade Auflage, mit Loch für M8 Schraube	3551 flat saddle, with single hole for M8 fixing bolt
geanodiseerd -18 mat zwart	anodisé -18 noir mat	eloxiert -18 matt schwarz	anodized -18 matt black

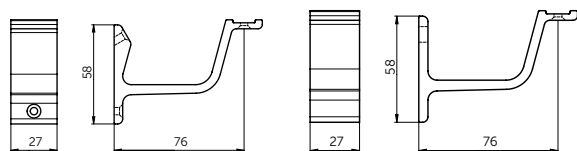

4 LEUNINGHOUDERS

LEUNINGHOUDERS LIFE



-18

LEUNINGHOUDER	SUPPORT DE MAIN COURANTE	HANDLAUFSTÜTZE	HANDRAIL BRACKET
van aluminium profiel	aluminium extrudé	Aluminiumprofil	extruded aluminium
76 mm	76 mm	76 mm	76 mm
De producten passen in een levensloopbestendige leefomgeving.	Les produits s'intègrent dans un environnement de vie résistant au cycle de la vie.	Die Produkte passen in eine Lebensphasen sichere Wohnumgebung.	The products fit well in an aging-in-place living environment.
ITS gecertificeerd (3B-113-011) TÜV gecertificeerd (2400-B-606) Cradle to cradle silver gecertificeerd (3692)	Certifié ITS (3B-113-011) Certifié TÜV (2400-B-606) Certifié argent berceau à berceau (3692)	ITS zertifiziert (3B-113-011) TÜV-zertifiziert (2400-B-606) Cradle to Cradle Silber zertifiziert (3692)	ITS certified (3B-113-011) TÜV certified (2400-B-606) Cradle-to-cradle silver certified (3692)
3552 holzadel, opschroevend	3552 concave, pour fixation au mur par vis	3552 gewölbte Auflage, zum Aufschraubenn	3552 radiused saddle, for screw fixing
3553 holzadel, met gat voor stokschroef M8	3553 concave, avec trou pour boulon M8	3553 gewölbte Auflage, mit Loch für M8 Schraube	3553 radiused saddle, with single hole for M8 fixing bolt
geanodiseerd -18 mat zwart	anodisé -18 noir mat	eloxiert -18 matt schwarz	anodized -18 matt black

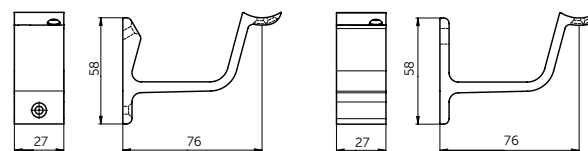

4 LEUNINGHOUDERS

ACCESSOIRES



-18

DOPMOER	ECROU BORGNE	HUTMUTTER	DOVE HEADED NUT
aluminium	aluminium	Aluminium	aluminium
5865 - M8 5866-18 E M8 (5 stuks)	5865 - M8 5866-18 E M8 (5 pièces)	5865 - M8 5866-18 E M8 (5 Stück)	5865 - M8 5866-18 E M8 (5 pieces)
geanodiseerd -18 mat zwart	anodisé -18 noir mat	eloxiert -18 matt schwarz	anodized -18 matt black



Grepen
Poignees
Griffe
Handles



HANDGREPEN



GREPEN	POIGNEES	GRIFFE	HANDLES
van aluminium profiel	aluminium extrudé	Aluminiumprofil	extruded aluminium
geanodiseerd -18 mat zwart	anodisé -18 noir mat	eloxiert -18 matt schwarz	anodized -18 matt black

	A	B	C	C1	C2	D	E
4200	90 mm	18 mm	78 mm			12 mm	
4201	110 mm	23 mm	95 mm			13 mm	
4203	150 mm	28 mm		120,5 mm	137,5 mm	20,5 mm	9,5 mm

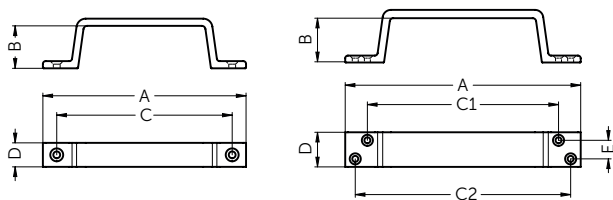

HANDGREPEN



GREPEN	POIGNEES	GRIFFE	HANDLES
van aluminium profiel	aluminium extrudé	Aluminiumprofil	extruded aluminium
geanodiseerd -18 mat zwart	anodisé -18 noir mat	eloxiert -18 matt schwarz	anodized -18 matt black

	A	B	C	D
4231	112 mm	21 mm	96 mm	14 mm
4232	149 mm	28 mm	128 mm	19 mm
4233	186 mm	35 mm	160 mm	24 mm

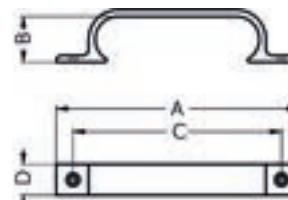

5 GREPEN

HANDGREPEN LIFE



GREPEN	POIGNEES	GRIFFE	HANDLES
geëpoxeerd -70 zwart	thermolaqué -70 noir	Aluminiumguß -70 schwarz	cast aluminium -70 black

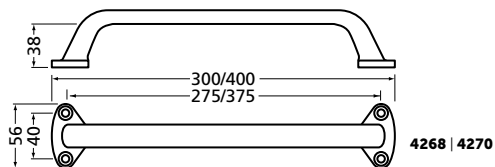
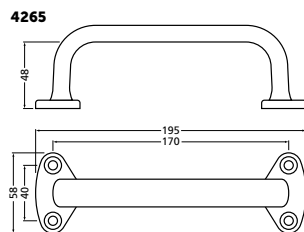
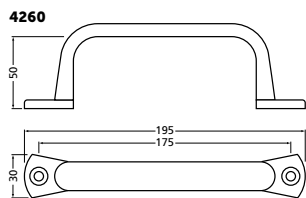

5 GREPEN

MEUBELGREPEN

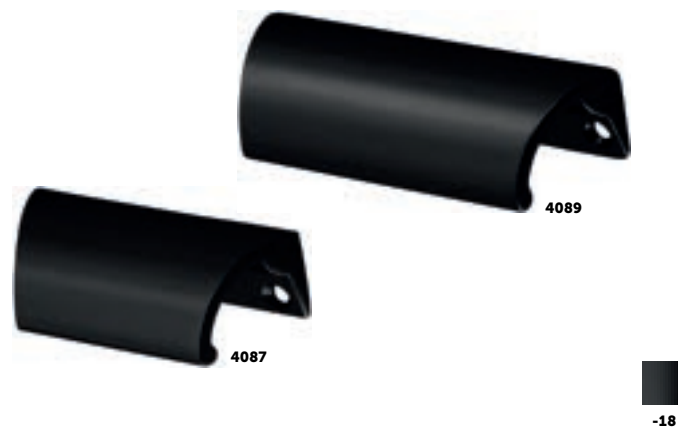

MEUBELGREPEN	POIGNEES DE MEUBLE	SCHUBLADENGRIFFE	DRAWER HANDLES
van aluminium profiel 2 x Ø 4 mm bevestigingsgaten	aluminium extrudé 2 trous de montage Ø 4 mm	Aluminiumprofil mit 2 x Ø 4 mm Löcher	extruded aluminium with 2 x 4 mm Ø fixing holes
geanodiseerd -18 mat zwart	anodisé -18 noir mat	eloxiert -18 matt schwarz	anodized -18 matt black

	A	B
4087	70 mm	58 mm
4089	90 mm	78 mm

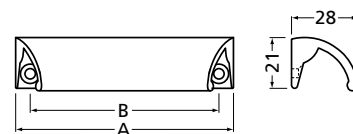

5 GREPEN

SCHUIFDEURKOMMEN



4555-70



4554

4555



-70

SCHUIFDEURKOM	POIGNEE CUVETTE POUR PORTE COULISSANTE	MUSCHELGRIFFE FÜR SCHIEBETÜR	FLUSH PULL
aluminium	aluminium	Aluminium	aluminium
rond model	modèle rond	rundes Modell	round model
geëpoxeerd -70 zwart	thermolaqué -70 noir	kunststoffbeschichtet -70 schwarz	epoxy plastic coated -70 black



4560-70

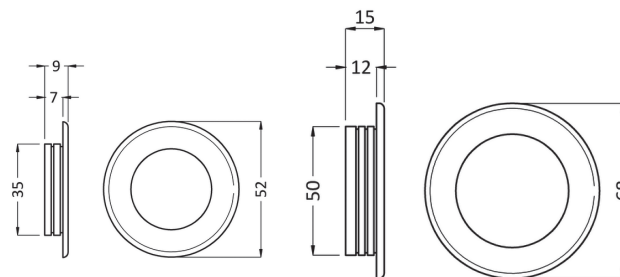

SCHUIFDEURKOMMEN



SCHUIFDEURKOM	POIGNEE CUVETTE POUR PORTE COULISSANTE	MUSCHELGRIFFE FÜR SCHIEBETÜR	FLUSH PULL
aluminium	aluminium	Aluminium	aluminium
rechthoekig model	modèle rectangulaire	Rechteckigen Modell	rectangular model
geëpoxeerd -70 zwart	thermolaqué -70 noir	kunststoffbeschichtet -70 schwarz	epoxy plastic coated -70 black

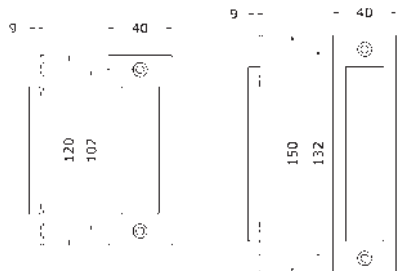

SCHUIFDEURKOMMEN



SCHUIFDEURKOM	POIGNEE CUVETTE POUR PORTE COULISSANTE	MUSCHELGRIFFE FÜR SCHIEBETÜR	FLUSH PULL
aluminium	aluminium	Aluminium	aluminium
ovaal model	modèle ovale	Oval Modell	oval model
geëpoxeerd -70 zwart	thermolaqué -70 noir	kunststoffbeschichtet -70 schwarz	epoxy plastic coated -70 black

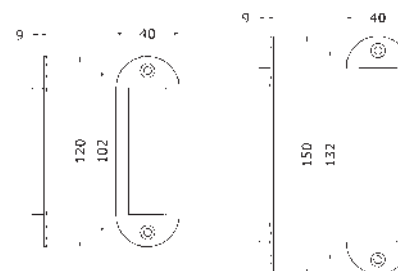

5 GREPEN

MEUBELKNOPPEN



3752-70



3755-70



3732-70



3731



3732



-70

MEUBELKNOPPEN	BOUTONS DE MEUBLE	MÖBELKNÖPFE	CUPBOARD KNOBS
van aluminium profiel	aluminium extrudé	Aluminiumprofil	extruded aluminium
cilindermodel met taggat M4	cylindrique trou taraudé M4	zylindrisch Gewindebohrung M4	cylindrical M4 threaded hole
geëpoxeerd -70 zwart	thermolaqué -70 noir	kunststofbeschildet -70 schwarz	epoxy plastic coated -70 black

	A	B
3731	20 mm	23 mm
3732	25 mm	26 mm

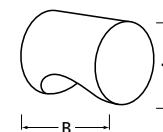

5 GREPEN

MEUBELKNOPPEN



MEUBELKNOP XL	BOUTON DE MEUBLE XL	MÖBELKNÖPF XL	CUPBOARD KNOB XL
van aluminium profiel	aluminium extrudé	Aluminiumprofil	extruded aluminium
met taggat M4 (3755)	trou taraudé M4 (3755)	Gewindebohrung M4 (3755)	M4 threaded hole (3755)
geëpoxideerd -70 zwart	thermolaqué -70 noir	kunststoffbeschildert -70 schwarz	epoxy plastic coated -70 black
MEUBELKNOPPEN	BOUTONS DE MEUBLE	MÖBELKNÖPFE	CUPBOARD KNOBS
gegoten aluminium	en fonte d'aluminium	Aluminiumguß	cast aluminium
met schroef M4 x 25 mm (3751, 3752 en 3753)	avec vis M4 x 25 mm (3751, 3752 et 3753)	Schraube M4 x 25 mm (3751, 3752 und 3753)	fixing bolt M4 x 25 mm (3751, 3752 and 3753)
geanodiseerd -70 zwart	anodisé -70 noir	eloxiert -70 schwarz	anodized -70 black

	A	B
3751	30 mm	20 mm
3752	35 mm	21 mm
3753	40 mm	22 mm
3755	50 mm	25 mm

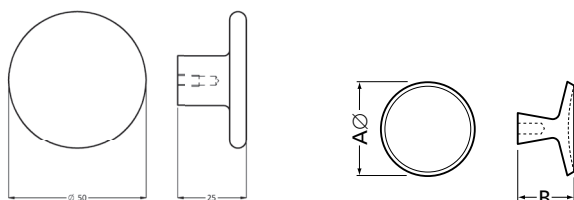

6 WANDSTEUNEN

WANDSTEUNEN



BEVESTIGINGSHOEK	EQUERRE d'ASSEMBLAGE	MONTAGEWINKEL	CORNER-CLASP
van aluminium profiel	aluminium extrudé	Aluminiumprofil	extruded aluminium
65 x 65mm	65 x 65mm	65 x 65mm	65 x 65mm
geanodiseerd -18 mat zwart	anodisé -18 noir mat	eloxiert -18 matt schwarz	anodized -18 matt black

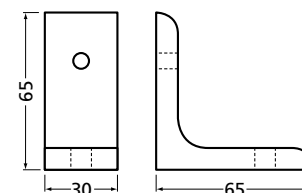

Gardelux® garderobesystemen

Gardelux® vestiaires

Gardelux® Garderoben

Gardelux® cloakroom systems



GARDELUX ANNA



GA7293-18



GA7293-36-18

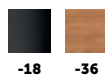

GARDELUX ANNA



GA7444-36-18



GA7444-18

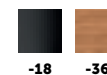

WANDMODEL	MODÈLE MURAL	WANDMODELL	WALL-MOUNTED
Multifunctionele wandgarderobe. Aan deze wandgarderobe kunt u niet alleen jassen kwijt, maar ook magazines, een spiegel of uw binnengekomen post plaatsen.	Une armoire murale multifonctionnelle. Cette armoire murale vous permet non seulement de ranger vos manteaux, mais aussi de ranger votre courrier entrant, un miroir ou des magazines.	Eine multifunktionale Wandgarderobe. An dieser Wandgarderobe können Sie nicht nur Mäntel, sondern auch Ihre eingehende Post, Zeitschriften oder einen Spiegel ablegen.	Multi-functional wall-mounted coat rack. This coat rack not only allows you to hang up coats, but there is also room to put down incoming mail, magazines or even a mirror.
Schuivende haken voor flexibele tussenruimte. Hygiënisch, gemakkelijk schoon te maken. Volledig gemaakt van duurzame materialen 75% gerecycled aluminium.	Crochets coulissants pour un espace flexible. Hygiénique, facile à nettoyer. Fabriqué entièrement à partir de matériaux durables en aluminium recyclé à 75%.	Verschiebbare Haken für flexible Abstände. Hygienisch, leicht zu reinigen. Komplett aus nachhaltigen Materialien 75% recyceltem Aluminium hergestellt.	Sliding hooks for flexible spacing. Hygienic, easy to clean. 100% made of sustainable materials 75% recycled aluminium.
3 haken	3 crochets	3 Haken	3 hooks
Inclusief montageset	Comprenant un set de montage	Inklusive Montagesatz	Including mounting set
7293-18 290x68x55 mm 7293-36-18 290x70x55 mm	7293-18 290x68x55 mm 7293-36-18 290x70x55 mm	7293-18 290x68x55 mm 7293-36-18 290x70x55 mm	7293-18 290x68x55 mm 7293-36-18 290x70x55 mm
In representatieve verpakking	Dans un emballage représentatif	In repräsentativer Verpackung	In representative packaging
-36 Geborsteld eikenhout/ -18 Mat zwart geanodiseerd aluminium	-36 Chêne brossé / -18 Noir mat anodisé aluminium	-36 Eichenholz, gebürstet/ -18 matt schwarz eloxiert Aluminium	-36 Brushed oak wood, -18 matt black anodised aluminium



WANDMODEL	MODÈLE MURAL	WANDMODELL	WALL-MOUNTED
Multifunctionele wandgarderobe. Aan deze wandgarderobe kunt u niet alleen jassen kwijt, maar ook magazines, een spiegel of uw binnengekomen post plaatsen.	Une armoire murale multifonctionnelle. Cette armoire murale vous permet non seulement de ranger vos manteaux, mais aussi de ranger votre courrier entrant, un miroir ou des magazines.	Eine multifunktionale Wandgarderobe. An dieser Wandgarderobe können Sie nicht nur Mäntel, sondern auch Ihre eingehende Post, Zeitschriften oder einen Spiegel ablegen.	Multi-functional wall-mounted coat rack. This coat rack not only allows you to hang up coats, but there is also room to put down incoming mail, magazines or even a mirror.
Schuivende haken voor flexibele tussenruimte. Hygiënisch, gemakkelijk schoon te maken. Volledig gemaakt van duurzame materialen 75% gerecycled aluminium.	Crochets coulissants pour un espace flexible. Hygiénique, facile à nettoyer. Fabriqué entièrement à partir de matériaux durables en aluminium recyclé à 75%.	Verschiebbare Haken für flexible Abstände. Hygienisch, leicht zu reinigen. Komplett aus nachhaltigen Materialien 75% recyceltem Aluminium hergestellt.	Sliding hooks for flexible spacing. Hygienic, easy to clean. 100% made of sustainable materials 75% recycled aluminium.
4 haken	4 crochets	4 Haken	4 hooks
Inclusief montageset	Comprenant un set de montage	Inklusive Montagesatz	Including mounting set
7444-18 440x68x55 mm 7444-36-18 440x70x55 mm	7444-18 440x68x55 mm 7444-36-18 440x70x55 mm	7444-18 440x68x55 mm 7444-36-18 440x70x55 mm	7444-18 440x68x55 mm 7444-36-18 440x70x55 mm
In representatieve verpakking	Dans un emballage représentatif	In repräsentativer Verpackung	In representative packaging
-36 Geborsteld eikenhout/ -18 Mat zwart geanodiseerd aluminium	-36 Chêne brossé / -18 Noir mat anodisé aluminium	-36 Eichenholz, gebürstet/ -18 matt schwarz eloxiert Aluminium	-36 Brushed oak wood, -18 matt black anodised aluminium



GARDELUX ANNA



GA7595-18



GA7595-36-18

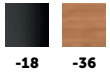

-18

-36

WANDMODEL	MODÈLE MURAL	WANDMODELL	WALL-MOUNTED
Multifunctionele wandgarderobe. Aan deze wandgarderobe kunt u niet alleen jassen kwijt, maar ook magazines, een spiegel of uw binnengekomen post plaatsen.	Une armoire murale multifonctionnelle. Cette armoire murale vous permet non seulement de ranger vos manteaux, mais aussi de ranger votre courrier entrant, un miroir ou des magazines.	Eine multifunktionale Wandgarderobe. An dieser Wandgarderobe können Sie nicht nur Mäntel, sondern auch Ihre eingehende Post, Zeitschriften oder einen Spiegel ablegen.	Multi-functional wall-mounted coat rack. This coat rack not only allows you to hang up coats, but there is also room to put down incoming mail, magazines or even a mirror.
Schuivende haken voor flexibele tussenruimte. Hygiënisch, gemakkelijk schoon te maken. Volledig gemaakt van duurzame materialen 75% gerecycled aluminium.	Crochets coulissants pour un espace flexible. Hygiénique, facile à nettoyer. Fabriqué entièrement à partir de matériaux durables en aluminium recyclé à 75%.	Verschiebbare Haken für flexible Abstände. Hygienisch, leicht zu reinigen. Komplett aus nachhaltigen Materialien 75% recyceltem Aluminium hergestellt.	Sliding hooks for flexible spacing. Hygienic, easy to clean. 100% made of sustainable materials 75% recycled aluminium.
5 haken	5 crochets	5 Haken	5 hooks
Inclusief montageset	Comprenant un set de montage	Inklusive Montagesatz	Including mounting set
7595-18 590x68x55 mm 7595-36-18 590x70x55 mm	7595-18 590x68x55 mm 7595-36-18 590x70x55 mm	7595-18 590x68x55 mm 7595-36-18 590x70x55 mm	7595-18 590x68x55 mm 7595-36-18 590x70x55 mm
In representatieve verpakking	Dans un emballage représentatif	In repräsentativer Verpackung	In representative packaging
-36 Geborsteld eikenhout / -18 Mat zwart, geanodiseerd aluminium	-36 Chêne brossé / -18 Noir mat, anodisé aluminium	-36 Eichenholz, gebürstet/ -18 matt schwarz eloxiert Aluminium	-36 Brushed oak wood, -18 matt black anodised aluminium



GA7595-18



ONDERDELEN GARDELUX 1

buizen



1014-1019



-18

GARDEROBEBUIS	TRINGLE	GARDEROBENROHR	WARDROBE TUBING
van aluminium profiel	aluminium extrudé	Aluminiumprofil	extruded aluminium
geanodiseerd -18 mat zwart	anodisé -18 noir mat	eloxiert -18 matt schwarz	anodized -18 matt black
Krasbestendig Levenslange garantie	Résistant aux rayures Garantie à vie	Kratzfest Lebenslange Garantie	Scratch resistant Lifetime Warranty

in verschillende maten leverbaar	disponible en différentes tailles	in verschiedenen großen erhältlich	available in different sizes
			L
1015			1000 mm
1016			1250 mm
1017			1500 mm
1014			2000 mm
1018			2500 mm
1019			3000 mm



ONDERDELEN GARDELUX 1

steunen



-70

STEUNEN IN DE DAG	SUPPORTS D'EXTREMITES POUR FIXATION LATÉRALE	WANDLAGER FÜR SEITLICHE BEFESTIGUNG	END BRACKETS FOR SIDE WALL MOUNTING
gegoten aluminium	en fonte d'aluminium	Aluminiumguß	cast aluminium
geëpoxeerd -70 zwart	thermolaqué -70 noir	kunststoffbeschichtet -70 schwarz	epoxy plastic coated -70 black

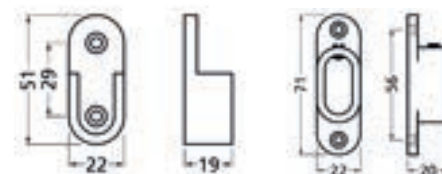

ONDERDELEN GARDELUX 1

steunen

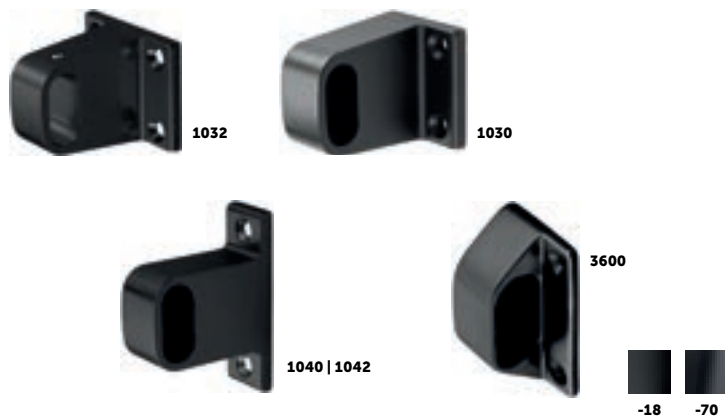

STEUNEN	SUPPORTS	TRÄGER	BRACKETS
van aluminium profiel	aluminium extrudé	Aluminiumprofil	extruded aluminium
1030 en 1040 eindsteun	1030 et 1040 supports d'extrémités	1030 und 1040 Endträger	1030 and 1040 end bracket
1032 en 1042 middensteun	1032 et 1042 supports intermédiaires	1032 und 1042 Mittelträger	1032 and 1042 middle bracket
3600 eindsteun	3600 support d'extrémité	3600 Endträger	3600 end bracket
1030, 1032, 1040, 1042 geanodiseerd -18 mat zwart	1030, 1032, 1040, 1042 anodisé -18 noir mat	1030, 1032, 1040, 1042 eloxiert -18 matt schwarz	1030, 1032, 1040, 1042 anodized -18 matt black
3600 geëpoxeerd -70 zwart	3600 thermolaqué -70 noir	3600 kunststoffbeschichtet -70 schwarz	3600 epoxy plastic coated -70 black

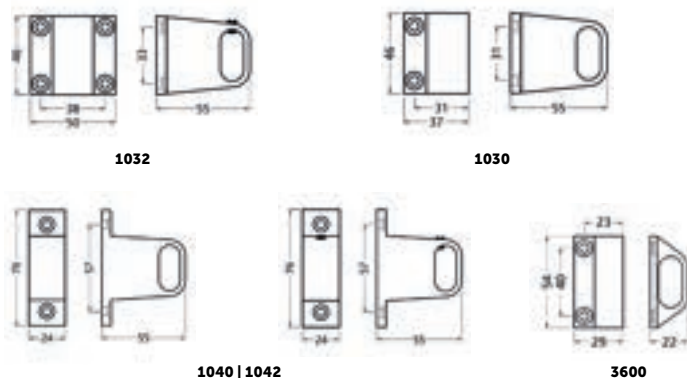

ONDERDELEN GARDELUX 1

steunen



STEUNEN VOOR PLAFOND BEVESTIGING	SUPPORTS POUR FIXATION AU PLAFOND	TRÄGER FÜR DECKENBEVESTIGUNG	BRACKETS FOR CEILING MOUNTING
van aluminium profiel	aluminium extrudé	Aluminiumprofil	extruded aluminium
opschroevend 1190 eindsteun 1192 middensteun met borgschroefje	2 trous de montage 1190 support d'extrémité 1192 support intermédiaire avec vis de serrage	zum Aufschrauben 1190 Endträger 1192 Mittelträger mit Fixierschraube	2 fixing holes 1190 end bracket 1192 middle bracket with locking screw
tapgat M6 1194 eindsteun 1196 middensteun met borgschroefje	trou taraudé M6 1194 support d'extrémité 1196 support intermédiaire avec vis de serrage	Gewindebohrung M6 1194 Endträger 1196 Mittelträger mit Fixierschraube	M6 threaded hole 1194 end bracket 1196 middle bracket with locking screw
geanodiseerd -18 mat zwart	anodisé -18 noir mat	eloxiert -18 matt schwarz	anodized -18 matt black

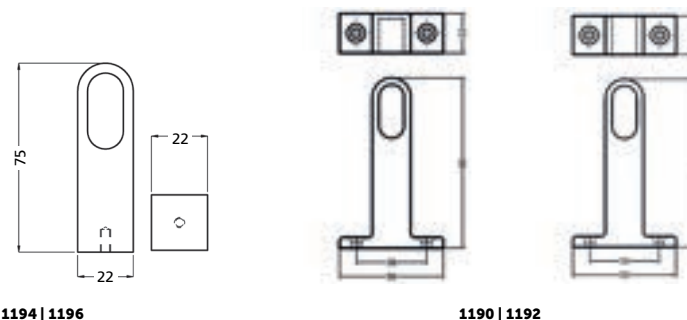

7 GARDELUX GARDEROBESYSTEMEN

ONDERDELEN GARDELUX 1

steunen



1150 | 1151 | 1152



1160 | 1161 | 1162



-70

BEUGELS VOOR BEVESTIGING AAN GARDEROBEBUIS	SUPPORTS POUR TRINGLE DE VESTIAIRE	TRÄGER FÜR BEFESTIGUNG AN GARDEROBENROHR	HANGING BRACKETS FOR FIXING TO WARDROBE TUBE
gegoten aluminium	en fonte d'aluminium	Aluminiumguß	cast aluminium
1150 en 1160 eindbeugels links	1150 et 1160 support d'extrémité gauche	1150 und 1160 Endträger links	1150 and 1160 left hand bracket
1151 en 1161 eindbeugels rechts	1151 et 1161 support d'extrémité droite	1151 und 1161 Endträger rechts	1151 and 1161 right hand bracket
1152 en 1162 middenbeugels	1152 et 1162 support d'intermédiaire	1152 und 1162 Mittelträger	1152 and 1162 middle bracket
geëpoxeerd -70 zwart	thermolaqué -70 noir	kunststoffbeschichtet -70 schwarz	epoxy plastic coated -70 black

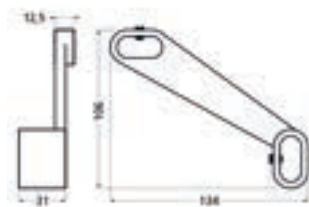
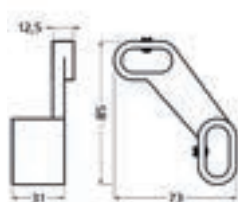

ONDERDELEN GARDELUX 1

steunen

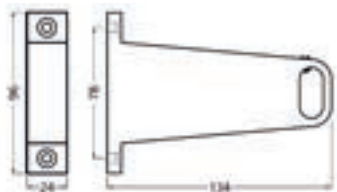

1050 | 1052

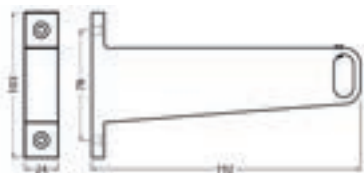

1070 | 1071 | 1072

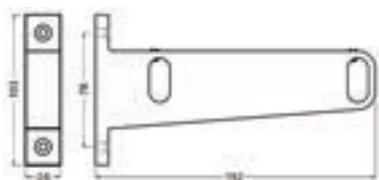

1080 | 1081 | 1082

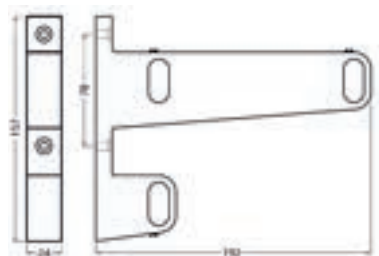

1090 | 1091 | 1092

ONDERDELEN GARDELUX 1

steunen



1050 | 1052



1080 | 1081 | 1082



1070 | 1071 | 1072



1090 | 1091 | 1092

-18

STEUNEN	SUPPORTS	TRÄGER	BRACKETS
van aluminium profiel	aluminium extrudé	Aluminiumprofil	extruded aluminium
1050 eindsteun links en rechts	1050 support d'extrémité gauche et droite	1050 Endträger links und rechts	1050 left and right hand bracket
1070, 1080 en 1090 eindsteunen links	1070, 1080 et 1090 support d'extrémité gauche	1070, 1080 und 1090 Endträger links	1070, 1080 and 1090 left hand bracket
1071, 1081 en 1091 eindsteunen rechts	1071, 1081 et 1091 support d'extrémité droite	1071, 1081 und 1091 Endträger rechts	1071, 1081 and 1091 right hand bracket
1052, 1072, 1082 en 1092 middensteunen	1052, 1072, 1082 et 1092 support intermédiaire	1052, 1072, 1082 und 1092 Mittelträger	1052, 1072, 1082 and 1092 middle bracket
geanodiseerd -18 mat zwart	anodisé -18 noir mat	eloxiert -18 matt schwarz	anodized -18 matt black
MONTAGESET VOOR STEUNEN	FIXATIONS POUR SUPPORTS	MONTAGEZUBEHÖR FÜR TRÄGER	FIXING KIT FOR BRACKETS
inhoud: 2 pluggen 2 stokschroeven M8 x 70 mm 2 dopmoeren M8	composition: 2 chevilles 2 vis captives M8 x 70 mm 2 écrous borgnes M8	Inhalt: 2 Dübel 2 Stokschrauben M8 x 70 mm 2 Hutmuttern M8	contents: 2 plugs 2 threaded screws M8 x 70 mm 2 M8 domeheaded nuts
geanodiseerd 2095-18 zwart	anodisé 2095-18 noir	eloxiert 2095-18 schwarz	anodized 2095-18 black



ONDERDELEN GARDELUX 1

steunen



1100 | 1101 | 1102

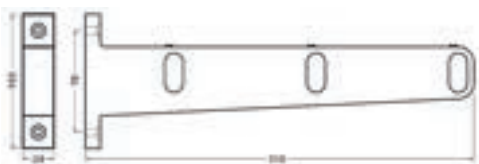

1110 | 1111 | 1112

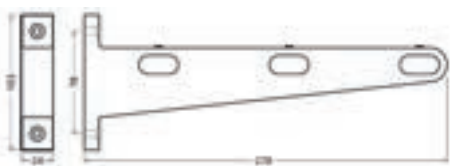

1102 | 1112 | 1132

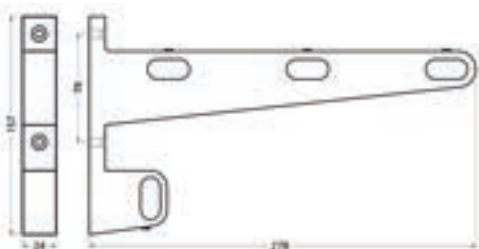

1140 | 1141 | 1142

ONDERDELEN GARDELUX 1

steunen



1100 | 1101 | 1102



1130 | 1131 | 1132



1110 | 1111 | 1112



1140 | 1141 | 1142

-18

STEUNEN	SUPPORTS	TRÄGER	BRACKETS
van aluminium profiel	aluminium extrudé	Aluminiumprofil	extruded aluminium
1100, 1110, 1130 en 1140 eindsteunen links	1100, 1110, 1130 et 1140 support d'extrémité gauche	1100, 1110, 1130 und 1140 Endträger links	1100, 1110, 1130 and 1140 left hand bracket
1101, 1111, 1131 en 1141 eindsteunen rechts	1101, 1111, 1131 et 1141 support d'extrémité droite	1101, 1111, 1131 und 1141 Endträger rechts	1101, 1111, 1131 and 1141 right hand bracket
1102, 1112, 1132 en 1142 middensteunen	1102, 1112, 1132 et 1142 support intermédiaire	1102, 1112, 1132 und 1142 Mittelträger	1102, 1112, 1132 and 1142 middle bracket
geanodiseerd -18 mat zwart	anodisé -18 noir mat	eloxiert -18 matt schwarz	anodized -18 matt black
MONTAGESET VOOR STEUNEN	FIXATIONS POUR SUPPORTS	MONTAGEZUBEHÖR FÜR TRÄGER	FIXING KIT FOR BRACKETS
inhoud: 2 pluggen 2 stokschroeven M8 x 70 mm 2 dopmoeren M8	composition: 2 chevilles 2 vis captives M8 x 70 mm 2 écrous borgnes M8	Inhalt: 2 Dübel 2 Stokschrauben M8 x 70 mm 2 Hutmuttern M8	contents: 2 plugs 2 threaded screws M8 x 70 mm 2 M8 domeheaded nuts
geanodiseerd 2095-18 zwart	anodisé 2095-18 noir	eloxiert 2095-18 schwarz	anodized 2095-18 black



ONDERDELEN GARDELUX 1

kledinghangers

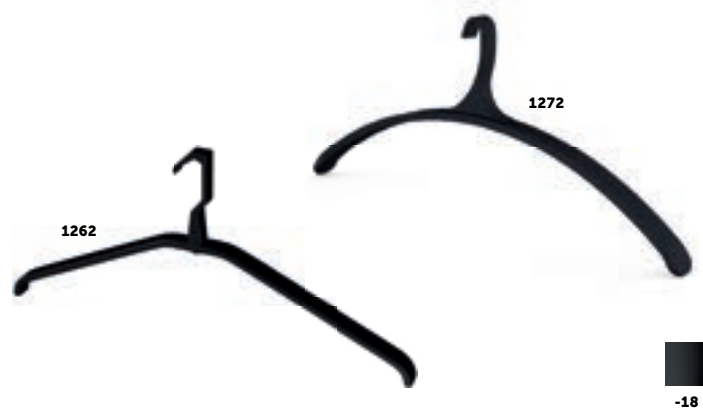

KLEDINGHANGERS 1262	CINTRES 1262	KLEIDERBÜGEL 1262	COAT HANGERS 1262
aluminium	aluminium	Aluminium	aluminium
zelfrichtend	non pivotant	selbstrichtend	selfaligning
geanodiseerd -18 mat zwart	anodisé -18 noir mat	eloxiert -18 matt schwarz	anodized -18 matt black
KLEDINGHANGERS 1272	CINTRES 1272	KLEIDERBÜGEL 1272	COAT HANGERS 1272
van aluminium profiel	aluminium extrudé	Aluminiumprofil	extruded aluminium
Zelfrichtend in combinatie met buis 1014-1019.	Auto-alignement en combinaison avec le tube 1014-1019.	Selbstrichtend in Kombination mit Rohr 1014-1019.	Self-aligning in combination with tube 1014-1019.
de vorm van de beugel is ideaal voor jassen.	La forme du support est idéale pour les vestes.	Die Form ist perfekt für Mantel.	Ideal shape for coats.
nieuw design.	nouveau design	neues Design	new design.
geanodiseerd -18 mat zwart	anodisé -18 noir mat	eloxiert -18 matt schwarz	anodized -18 matt black

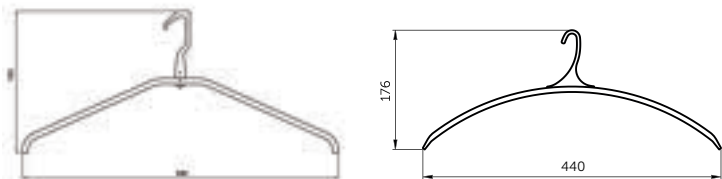

ONDERDELEN GARDELUX 1

haken



GARDEROBEHAKEN	CROCHETS DE VESTIAIRE	GARDEROBEHAKEN	HAT AND COAT HOOKS
aluminium	aluminium	Aluminium	aluminium
Alle haken met een bord-schroefje behalve 1205.	Tous crochets avec vis de serrage sauf 1205.	Alle Haken mit Fixier-schraube außer 1205.	All hooks have locking screw except 1205.
1201, 1205 geanodiseerd -18 mat zwart	1201, 1205 anodisé -18 noir mat	1201, 1205 eloxiert -18 matt schwarz	1201, 1205 anodized -18 matt black
1220, 1221, 1230, 1231 geëpoxeerd -70 zwart	1220, 1221, 1230, 1231 thermolaqué -70 noir	1220, 1221, 1230, 1231 kunststofbeschildet -70 schwarz	1220, 1221, 1230, 1231 epoxy plastic coated -70 black

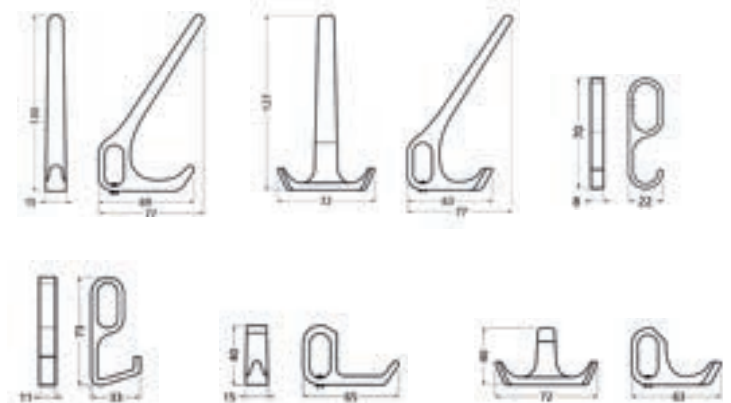

Deurbuffers
Arrêts de porte
Türpuffer
Doorchecks



4735-18



4702-18

8 DEURTOEBEHOREN

DEURBUFFERS



DEURBUFFERS	ARRÊTS DE PORTE	TÜRPUFFER	DOORCHECKS
met buffer van zacht kunststof, zwart	avec butoir en matière synthétique, tendre, noir	mit Puffer von Kunststoff, weich, schwarz	with soft plastic buffer, black
van aluminium profiel onzichtbare bevestiging 4700 - L = 25 mm 4702 - L = 50 mm 4704 - L = 60 mm	aluminium extrudé fixation cachée 4700 - L = 25 mm 4702 - L = 50 mm 4704 - L = 60 mm	Aluminiumprofil Befestigung verdeckt 4700 - L = 25 mm 4702 - L = 50 mm 4704 - L = 60 mm	extruded aluminium invisible mounting 4700 - L = 25 mm 4702 - L = 50 mm 4704 - L = 60 mm
4735 van aluminium profiel met tapgat M8	4735 aluminium extrudé trou taraudé M8	4735 Aluminiumprofil Gewindebohrung M8	4735 extruded aluminium M8 threaded hole
geanodiseerd -18 mat zwart	anodisé -18 noir mat	eloxiert -18 matt schwarz	anodized -18 matt black
LOSSE BUFFER	BUTOIR VRAC	LOSE PUFFER	LOOSE BUFFER
4709-80 zwart	4709-80 noir	4709-80 schwarz	4709-80 black

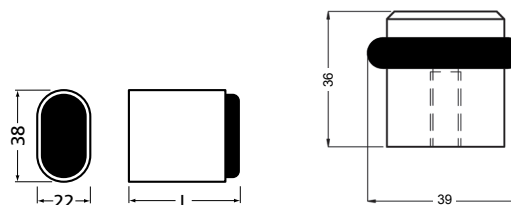

ARTIKELNUMMERS

REGISTRE DE NUMÉRO | NUMMERNREGISTER | NUMBER REGISTER

0030	22	1140 t/m 1142	79	4201	52
0031	22	1150 t/m 1152	74	4203	52
0032	23	1160 t/m 1162	74	4231	53
0033	23	1170	71	4252	53
0111	24	1175	71	4233	53
0115	19	1190	73	4260	54
0129	24	1192	73	4265	54
0138	25	1194	73	4268	54
0139	19	1196	73	4270	54
0148	25	1201	81	4554	57
0149	25	1205	81	4555	57
0150	29	1220	81	4556	58
0200	28	1221	81	4558	58
0201	28	1230	81	4560	59
0551	18	1231	81	4562	59
0553	18	1262	80	4700	83
0554	24	1272	80	4702	83
0555	19	3500	40	4704	83
0557	18	3501	40	4709	83
0863	37	3502	41	4735	83
1014 t/m 1019	70	3503	41	5500	63
1030	72	3505	42	5865	49
1032	72	3506	42	GA7923	66
1040	72	3507	43	GA7444	67
1042	72	3508	43	GA7595	69
1050	77	3540	44	X001.01	32
1052	72	3541	44	X002.01	33
1070 t/m 1072	77	3542	45	X002.03	33
1080t/m 1082	77	3543	45	X002.04	33
1090 t/m 1092	77	3550	46	X003.01	34
1100 t/m 1102	79	3551	46	X003.04	34
1110 t/m 1112	79	3552	47	X028	35
1130 t/m 1132	79	3553	47	X029	35
		3731	61		
		3732	61		
		3751 t/m 3753	62		
		3755	62		
		4087	55		
		4089	55		
		4200	52		





PRODUCT OVERZICHT

Aluminium	10	Hermeta Life	6	Onderdelen leuninghouders	49
Cradle to Cradle certification	6	Hermeta: Aluminium Design	10	Schuifdeurkommen	57-59
Deurbuffers	82	Inhoudsopgave	2	Schuifhaken	81
Gardelux®	64	Jashaken	24, 25	Steunen voor garderobebuis	71-79
Gardelux® 1	70-81	Jashaken Originals	22, 23	Wandgarderobes	36
Gardelux® ANNA	66-69	Jashaken voor		Wandsteunen	63
Garderobebuis	70	plafondbevestiging	28	X'tenz haken	32-35
Garderobehaken	81	Kastinterieur	70		
Grepen	50-62	Leuninghouders	40-47		
Haken	16	Magneethaken	29		
Handdoekhaken	18, 19	Meubelgrepen	61		
Handgrepen	52-55	Meubelknoppen	61		
Hermeta Blackline	14	Nummerregister	84		
Hermeta Blue	6	Onderdelen Gardelux®	70-81		

MOT CLÉ REGISTRE

Aluminium	10	Électeurs de support		Poignées	52-55
Arrêts de porte	82	de main courante	49	Porte manteaux	36
Boutons de meuble	61	Électeurs Gardelux®	70-81	Registre de numero	84
Boutons de meuble	61	Equerre d'assemblage	63	Support de main courante	40-47
Cradle to Cradle certification	6	Gardelux® 1	70-81	Support de tringle	71-79
Crochet magnetiques	29	Gardelux® ANNA	66-69	Table des Matières	2
Crochet portemanteau	24, 25	Gardelux® vestiaires	64	Tringle	70
Crochet portemanteau		Hermeta Blackline	14		
Originals	22, 23	Hermeta Blue	6		
Crochet pour fixation au plafond	28	Hermeta Life	6		
Crochets	16	Hermeta: Aluminium Design	10		
Crochets coulissants	81	intérieur du cabinet	70		
Crochets de vestiaire	81	Poignée cuvette			
Crochets pour essuie-mains	18, 19	porte coulissante	57-59		
Crochets X'tenz	32-35	Poignées	50-62		





SCHLÜSSELWORTREGISTER

Cradle to Cradle certification	6	Hermeta Life	6	Schränkenraum	70
Gardelux® 1	70-81	Hermeta: Aluminium Design	10	Türpuffer	82
Gardelux® ANNA	66-69	Inhaltsverzeichnis	2	verschiebbare Haken	81
Gardelux® Garderoben	64	Magnethaken	29	Wähler Gardelux®	70-81
Garderobenrohr	70	Mantelhaken	24, 25	Wähler Handlaufstutze	49
Garderobenleisten	36	Mantelhaken für		X'tenz Haken	32-35
Garderobenhaken	81	Deckenbefestigung	28		
Griffe	50-62	Mantelhaken Originals	22, 23		
Griffe	52-55	Moebelknoepfe	61		
Haken	16	Moebelknoepfe	61		
Handlaufstutze	40-47	Montagewinkel	63		
Handtuchhaken	18, 19	Muschelgriffe für Schiebetür	57-59		
Hermeta Blackline	14	Nummerregister	84		
Hermeta Blue	6	Rohrträger	71-79		

KEYWORD REGISTER

Aluminium	10	Gardelux® 1	70-81	Number register	84
Cabinet interior	70	Gardelux® ANNA	66-69	sliding hooks	81
Coat hook for ceiling mounting	28	Gardelux® cloakroom systems	64	Towel hooks	18, 19
Coat hooks	24, 25	Handles	50-62	Tube supports	71-79
Coat hooks Originals	22, 23	Handles	52-55	Wardrobe tubing	70
Coat racks	36	Handrail bracket	40-47	X'tenz hooks	32-35
Components Gardelux®	70-81	Hat and coat hooks	81		
Components handrail bracket	49	Hermeta Blackline	14		
Corner clasp	63	Hermeta Blue	6		
Cradle to Cradle certification	6	Hermeta Life	6		
Cupboard knobs	61	Hermeta: Aluminium Design	10		
Cupboard knobs	61	Hooks	16		
Doorchecks	82	Index	2		
Flush pull	57-59	Magnetic hooks	29		



**Hermeta Interieuraccessoires
& Garderobesystemen**

**Hermeta Quincaillerie
Intérieur & Vestiaires**

**Hermeta Bau- und
Möbelbeschläge & Garderoben**

**Hermeta Interior Hardware
& Cloakroom systems**

Hermeta Metaalwaren bv
1e Industrieweg 1,
4147 CR Asperen
The Netherlands

P.O. Box 1017,
4147 ZG Asperen
The Netherlands

phone: +31 (0) 345-63 48 74
fax: +31 (0) 345-63 48 77
sales@hermeta.nl
www.hermeta.nl



**Hermeta Interieuraccessoires
& Garderobesystemen**

**Hermeta Quincaillerie
Intérieur & Vestiaires**

**Hermeta Bau- und
Möbelbeschläge & Garderoben**

**Hermeta Interior Hardware
& Cloakroom systems**



hermeta

+31 (0) 345-63 48 74 | sales@hermeta.nl
www.hermeta.nl